

WALLSLIDE

TRUCK WALLSLIDE PARTS CATALOG

FORD F-150

6.5 FT BED



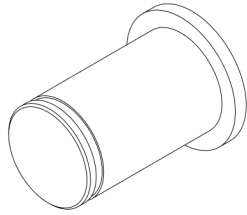

CG1000XL, 1500XL, and 2200XL

6201 Side Thrust

Bearing Pin

#030280

L-8.29"

D-0.470"

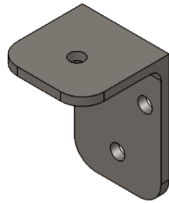

WS-Canopy

Bumper Mount

#180203

L- 2"

W- 3"

H- 2"

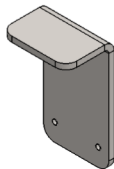

WS-Canopy

Bumper Stop

#180202

L-7"

W-3"

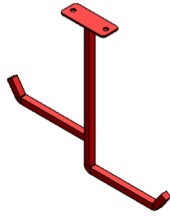

WS-Canopy

Ladder Rack

#180204

L- 4"

W-1-1/2"



WSF-4x6 inch

Base Foot Spacer

#180530

L- 4"

W- 1"



WSF-6 inch

Base Foot Spacer

#180529

L- 6"

W- 1"



WSF-8 inch
Base Foot Spacer

#180528

L- 8"

W- 1"

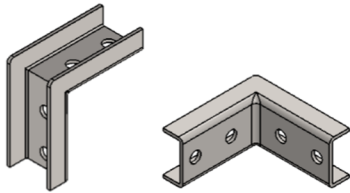

WSF- ClamShells
2 Way Inside Corner

#180151

L- 3.238"

W- 1.5"

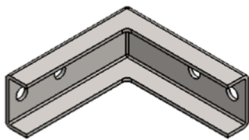

WSF- ClamShells
2 Way Outside Corner

#180150

L- 4"

W- 1.500"

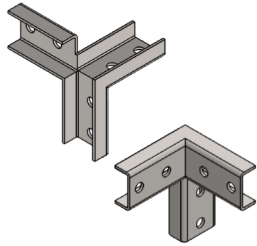

WSF- ClamShells

3 Way Inside Corner

#180153

L- 4"

W- 1.500"

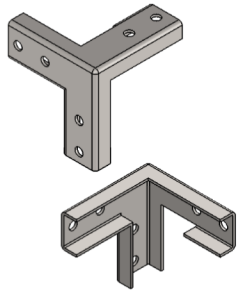

WSF- ClamShells

3 Way Outside Corner

#180152

L- 4"

W- 1.500"

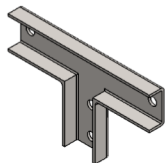

WSF- ClamShells

3 Way Tee

#180154

L- 6.500"

W- 4"

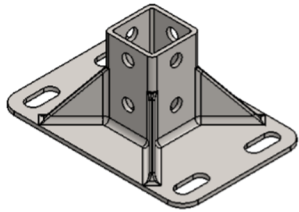

WSF- Frame

4x6 Base Foot

#180158

L- 4"

W- 6"

H- 2.625"

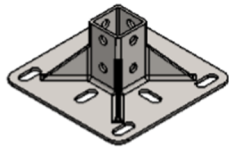

WSF- Frame

6x6 Base Foot

#180156

L- 6"

W- 6"

H- 2.625"

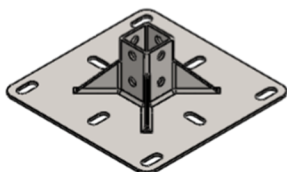

WSF- Frame

8x8 Base Foot

#180158

L- 8"

W- 8"

H- 2.625"

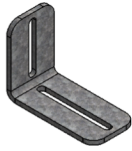

WSF-Frame
Unistrut Angle Bracket

#180206

L- 4"

W- 2"

H- 3"

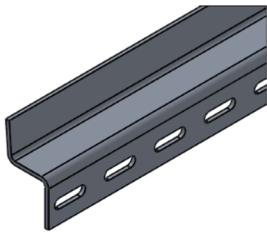

WS-Frame
Snake Track Extrusion

#180319

L-96"

W-1.380"

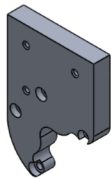

WSM-Bearing Rail
Motor Mount

#180179

L-5.554"

W-3.976"

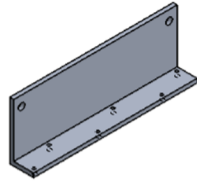

WSM-Bearing Rails
Limit Switch Mount

#180218

L- 5.125"

W- 1.800"

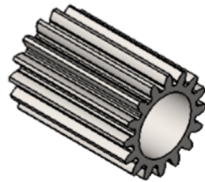

WSM-Motor
Motor Pinion Gear

#180320

L- 1-1/2"

D- 3/4"

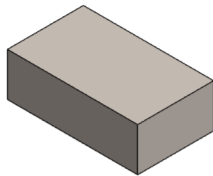

WSR-Rails
Latch Rod Paddle

#180313

L-1-1/2"

W-7/8"

H-1/2"

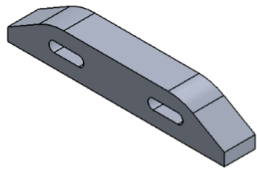

WSM-Rails
Limit Switch Striker

#180219

L- 4.375"

W- 0.625"



WSP-Acuator
Connecting Rod

#180518

L- 9.8"

W- 0.188"

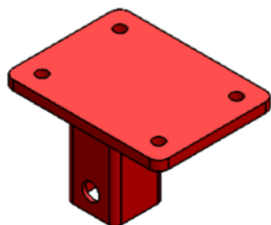

WSP-Canopy
Handle Bracket

#180214

L- 4"

W- 3"

H- 2"

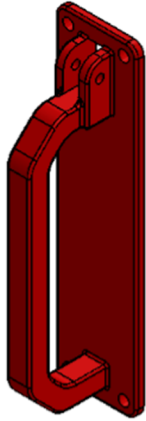

WSP-Handle

Latch Handle Pull

#180317

L- 8"

W- 2"

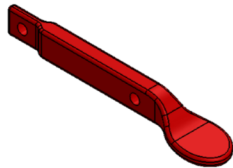

WSP-Handle

Thumb Lever

#180318

L- 4.438"

W- 0.500"

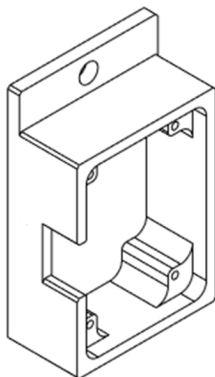

WSP-JSNSR04T

Enclosure Housing

#180330

L- 2.375"

W- 0.750"

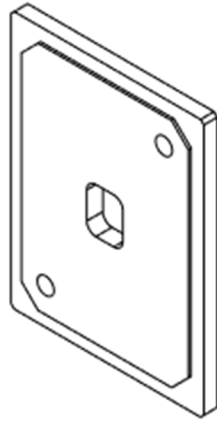

WSP-JSNSR04T

Enclosure Lid

#180331

L- 2"

W- 1.5"

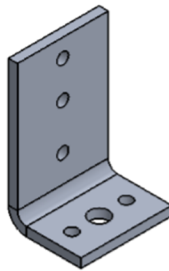

WSP-Snake Track

End Support Bracket

#180216

L- 2"

W- 1.250"

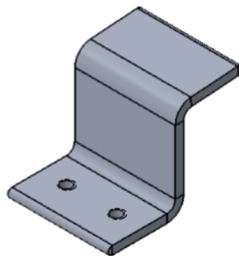

WSP-Snake Track

Single Support

#180314

L- 1.500"

W- 1.500"

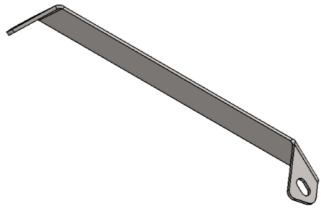

WSP-Wall Sheet

Canopy Bracket

#180205

L- 14.750"

W- 1"

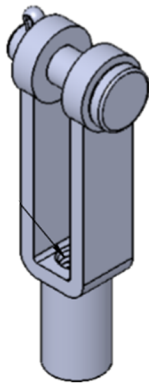

WSP-Wall Sheet

Clevis Rod End

#180322

L- 1.563"

W- 0.438"

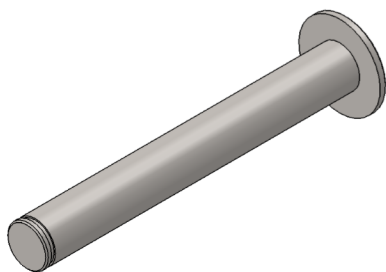

WSR-Bearing Rails

HD Thrust Bearing Pin

#180194

L- 2.402"

W- 0.310"

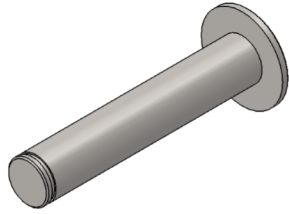

WSR-Bearing Rails-HD
Single Thrust Bearing Pin

#180196

L- 1.647"

W- 0.310"

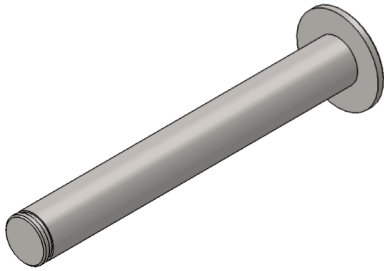

WSR-Bearing Rails
HD Thrust Bearing Pin

#180194

L- 2.402"

W- 0.310"

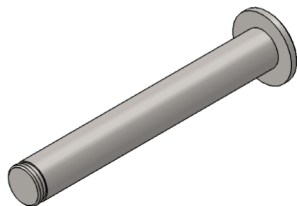

WSR-Bearing Rails
Main Bearing Pin

#180191

L- 1.835"

D- 0.248"

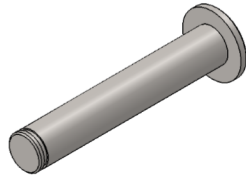

WSR-Bearing Rails
Single Thrust Bearing Pin

#180195

L- 1.441"

W- 0.248"

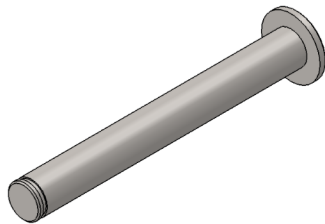

WSR-Bearing Rails
Thrust Bearing Pin

#180192

L- 2.055"

D- 0.248"

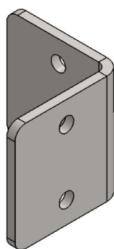

WSR-Rails
Closure Stop

#180215

L- 2.5"

W- 2.492"

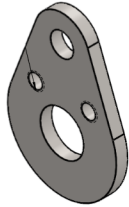

WSR-Rails

Cranklink

#180211

L- 1.821"

W- 0.125"

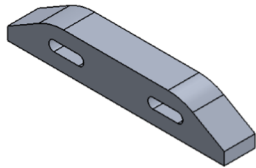

WSM-Rails

Limit Switch Striker

#180219

L- 4.375"

W- 0.625"

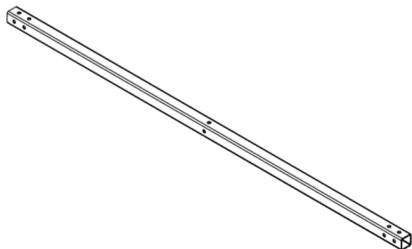

F-150

Cross Support

#180299

L- 49-1/4"

W- 1-1/4"

H- 1-1/4"

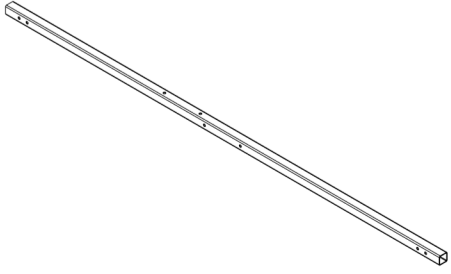

F-150

Upper Horizontal

#180298

L- 67-7/8"

W- 1-1/4"

H- 1-1/4"

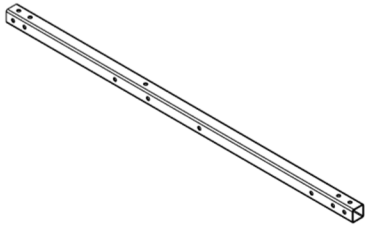

F-150

Main Upright

#180300

L- 38"

W- 1-1/4"

H- 1-1/4"

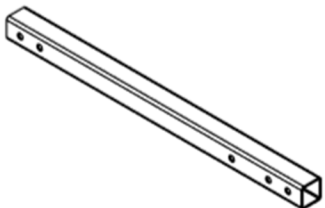

F-150

Mid Upright

#180301

L- 18.927"

W- 1-1/4"

H- 1-1/4"

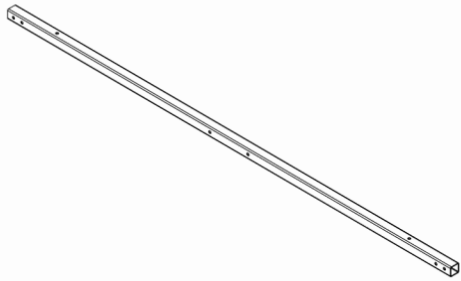

F-150

Lower Horizontal

#180302

L- 65.375"

W- 1-1/4"

H- 1-1/4"

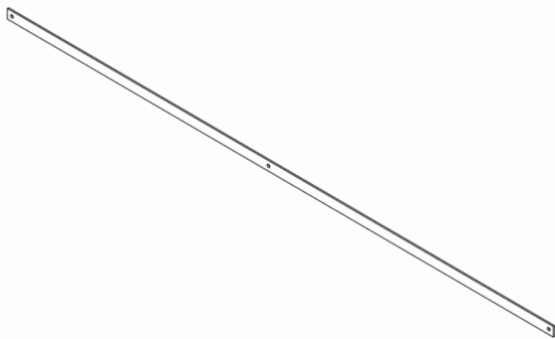

F-150

Side Stabilizer

#180303

L- 75"

W- 1-1/4"

Thickness- 3/16"

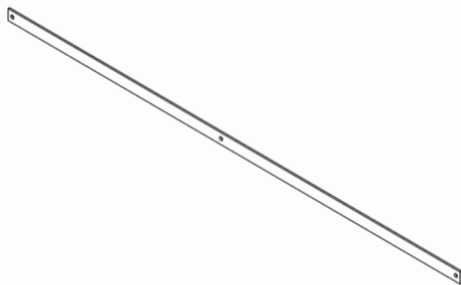

F-150

Back Stabilizer

#180304

L- 54.500"

W- 1-1/4"

Thickness- 3/16"



F-150
Left Upper Bearing Rail

#180305

L-70"

W- 2.875"

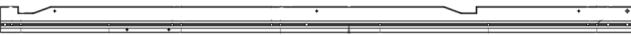

F-150
Left Lower Bearing Rail

#180306

L-70"

W- 2.875"



F-150
Left Sliding Rail

#180307

L-70"

W- 3.875"



F-150
Right Upper Bearing Rail

#180308

L-70"

W- 2.875"



F-150
Right Lower Bearing Rail

#180309

L-70"

W- 2.875"

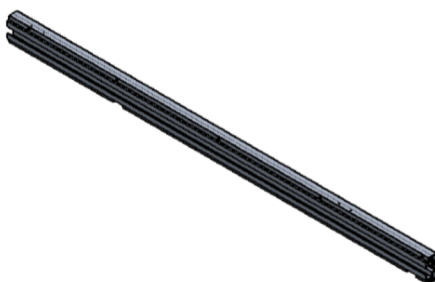

F-150
Right Sliding Rail

#180310

L-70"

W- 3.875"

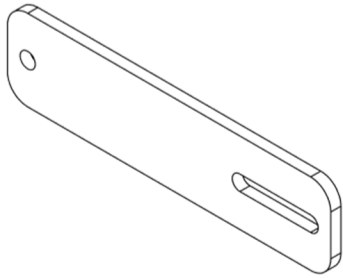

F-150
Frame Mounting Strap

#180323

L-8"

W-2"

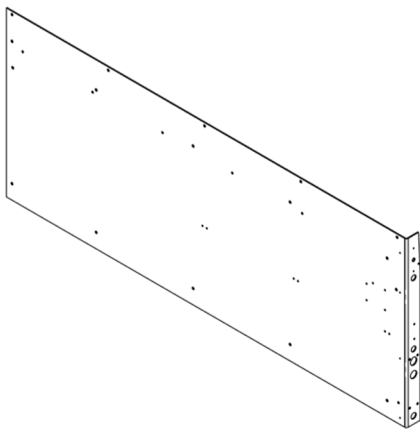

F-150
Right Wall Panel

#180492

L-70.141"

W-28.625"

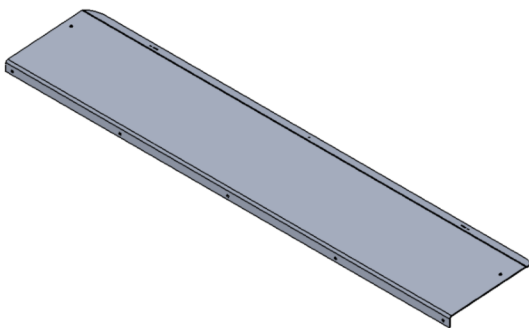

F-150
Wall Canopy

#180493

L-69.500"

W-13.728"

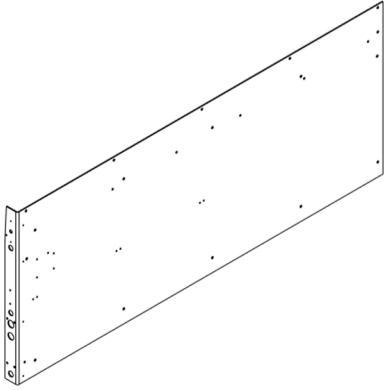

F-150

Left Wall Panel

#180494

L-70.141"

W-28.625"



F-150

Gear Rack

#180496

L-52"

W-0.7500"

H-0.7500"



F-150

Canopy Bearing Rail

#180497

L-70"

W-2.875"

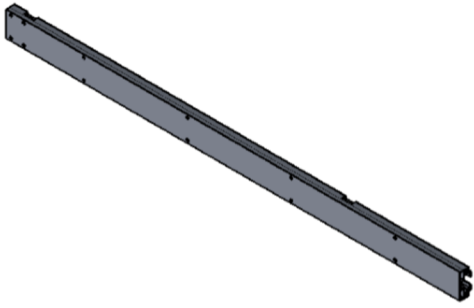

F-150

Canopy Sliding Rail

#180498

L-70"

W-3.875"

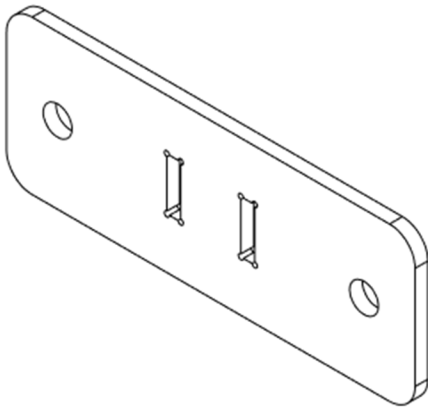

Folding Ladder Rack

Base

#180481

L- 4"

W- 1.500"

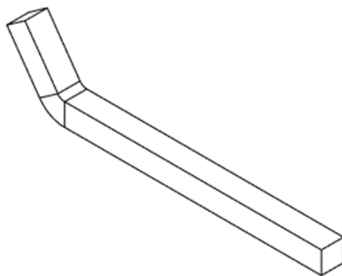

Folding Ladder Rack

Hook 2

#180488

L- 7.500"

W- 0.500"

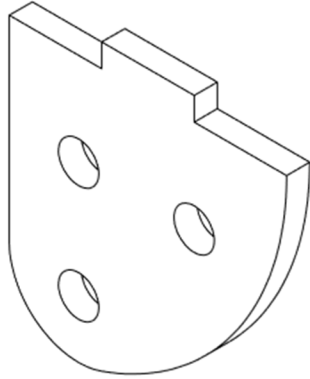

Folding Ladder Rack

Pivot Plate

#180482

L- 1.540"

W- 1.500"

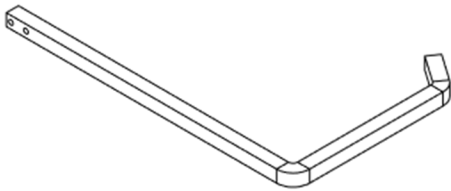

Folding Ladder Rack

Main Hook

#180487

L- 11.895"

W- 7.537"

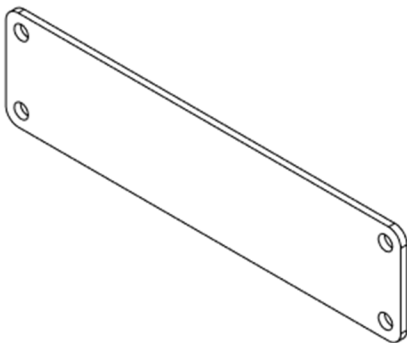

Logo Plate

Back Plate

#180504

L- 8"

W- 2"

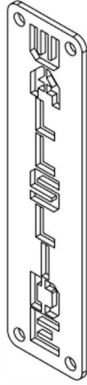

WallSlide Vertical

Logo Plate

#180532

L- 8"

W- 2"