

WALLSLIDE

WALLSLIDE PARTS CATALOG

FORD TRANSIT
148" WHEEL BASE
MID-ROOF

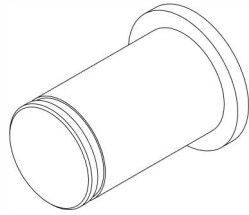



CG1000XL, 1500XL, and 2200XL

6201 Side Thrust

Bearing Pin

#030280

L-8.29"

D-0.470"

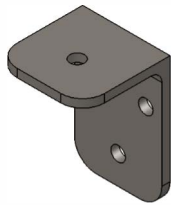

WS-Canopy

Bumper Mount

#180203

L- 2"

W- 3"

H- 2"

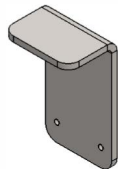

WS-Canopy

Bumper Stop

#180202

L-7"

W-3"

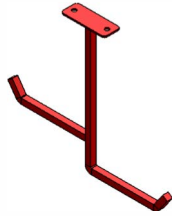

WS-Canopy

Ladder Rack

#180204

L- 4"

W-1-1/2"



WSF-4x6 inch

Base Foot Spacer

#180530

L- 4"

W- 1"



WSF-6 inch

Base Foot Spacer

#180529

L- 6"

W- 1"



WSF-8 inch
Base Foot Spacer

#180528

L- 8"

W- 1"

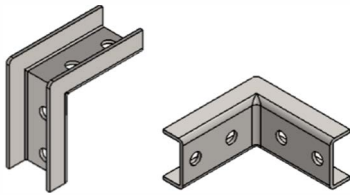

WSF- ClamShells
2 Way Inside Corner

#180151

L- 3.238"

W- 1.5"

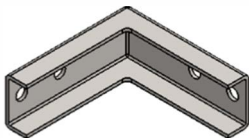

WSF- ClamShells
2 Way Outside Corner

#180150

L- 4"

W- 1.500"

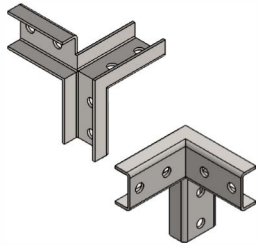

WSF- ClamShells

3 Way Inside Corner

#180153

L- 4"

W- 1.500"

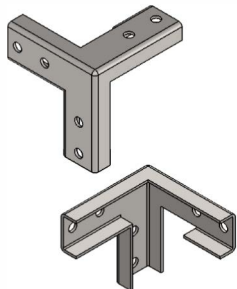

WSF- ClamShells

3 Way Outside Corner

#180152

L- 4"

W- 1.500"

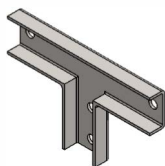

WSF- ClamShells

3 Way Tee

#180154

L- 6.500"

W- 4"

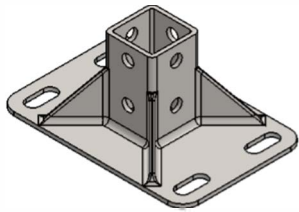

WSF- Frame

4x6 Base Foot

#180158

L- 4"

W- 6"

H- 2.625"

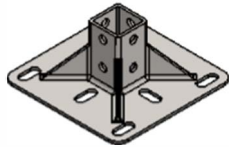

WSF- Frame

6x6 Base Foot

#180156

L- 6"

W- 6"

H- 2.625"

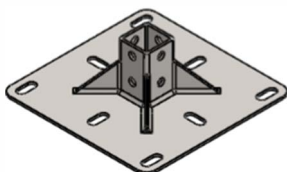

WSF- Frame

8x8 Base Foot

#180158

L- 8"

W- 8"

H- 2.625"



WSF-Frame
Unistrut Angle Bracket

#180206

L- 4"

W- 2"

H- 3"

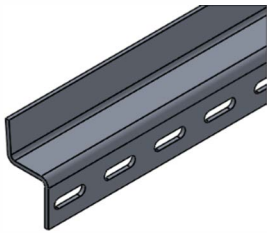

WS-Frame
Snake Track Extrusion

#180319

L-96"

W-1.380"

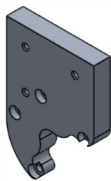

WSM-Bearing Rail
Motor Mount

#180179

L-5.554"

W-3.976"

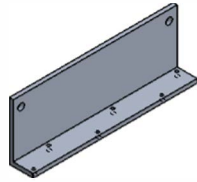

WSM-Bearing Rails
Limit Switch Mount

#180218

L- 5.125"

W- 1.800"

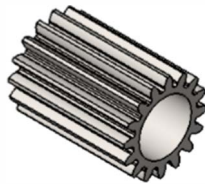

WSM-Motor
Motor Pinion Gear

#180320

L- 1-1/2"

D- 3/4"

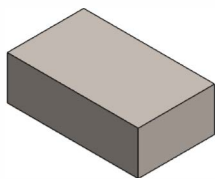

WSR-Rails
Latch Rod Paddle

#180313

L-1-1/2"

W-7/8"

H-1/2"

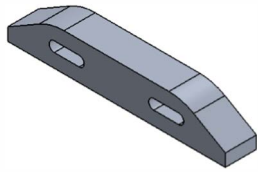

WSM-Rails
Limit Switch Striker

#180219

L- 4.375"

W- 0.625"



WSP-Acuator
Connecting Rod

#180518

L- 9.8"

W- 0.188"

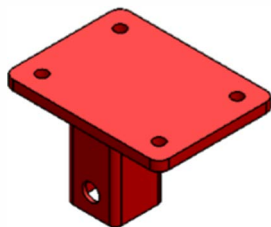

WSP-Canopy
Handle Bracket

#180214

L- 4"

W- 3"

H- 2"

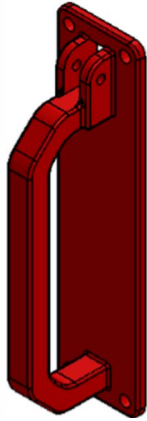

WSP-Handle

Latch Handle Pull

#180317

L- 8"

W- 2"

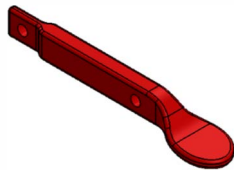

WSP-Handle

Thumb Lever

#180318

L- 4.438"

W- 0.500"

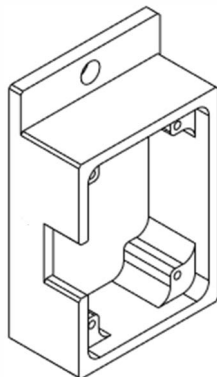

WSP-JSNSR04T

Enclosure Housing

#180330

L- 2.375"

W- 0.750"

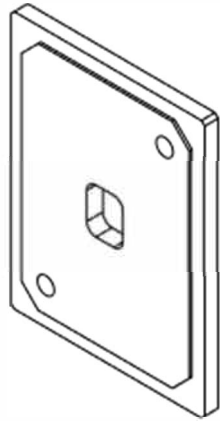

WSP-JSNSR04T

Enclosure Lid

#180331

L- 2"

W- 1.5"

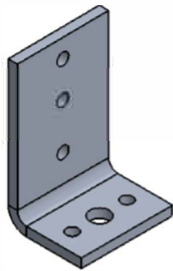

WSP-Snake Track

End Support Bracket

#180216

L- 2"

W- 1.250"

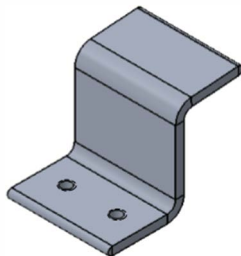

WSP-Snake Track

Single Support

#180314

L- 1.500"

W- 1.500"

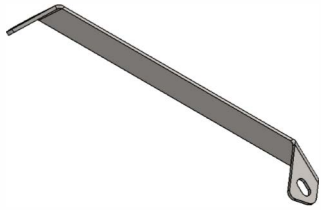

WSP-Wall Sheet

Canopy Bracket

#180205

L- 14.750"

W- 1"

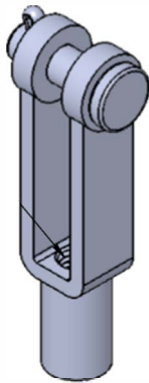

WSP-Wall Sheet

Clevis Rod End

#180322

L- 1.563"

W- 0.438"

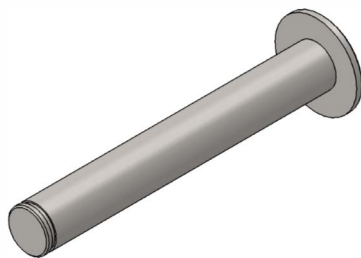

WSR-Bearing Rails

HD Main Bearing Pin

#180193

L- 2.207"

D- 0.310"

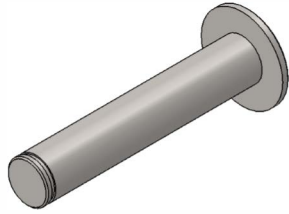

WSR-Bearing Rails-HD
Single Thrust Bearing Pin

#180196

L- 1.647"

W- 0.310"

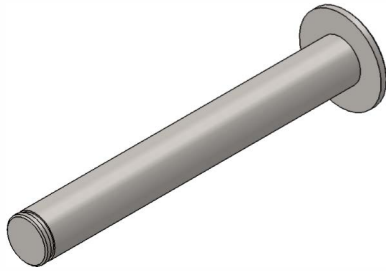

WSR-Bearing Rails
HD Thrust Bearing Pin

#180194

L- 2.402"

W- 0.310"

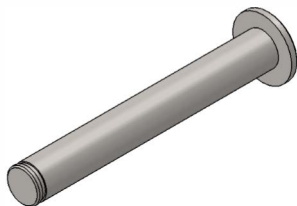

WSR-Bearing Rails
Main Bearing Pin

#180191

L- 1.835"

D- 0.248"

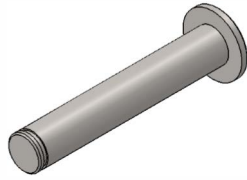

WSR-Bearing Rails
Single Thrust Bearing Pin

#180195

L- 1.441"

W- 0.248"

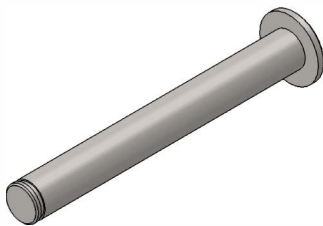

WSR-Bearing Rails
Thrust Bearing Pin

#180192

L- 2.055"

D- 0.248"

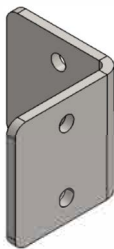

WSR-Rails
Closure Stop

#180215

L- 2.5"

W- 2.492"

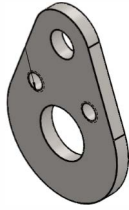

WSR-Rails

Cranklink

#180211

L- 1.821"

W- 0.125"

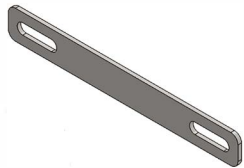

Transit

WallSlide-Frame

Mounting Strap

#180212

L- 8"

W- 1"



WSF-Sprinter

Cross Support

#180115

L- 56.375"

W- 1-1/4"

H- 1-1/4"



WSF-Sprinter
Frame Mounting Strap

#180213

L- 10-1/2"

W- 1"



WSF-Sprinter
Front Stabilizer

#180113

L- 76.180"

W- 1-1/4"

Thickness- 3/16"



WSF-Sprinter
Main Upright

#180114

L- 60"

W- 1-1/4"

H- 1-1/4"



WSF-Sprinter

Mid Upright

#180116

L- 47.125"

W- 1-1/4"

H- 1-1/4"



WSF-Sprinter

Rear Stabilizer

#180112

L- 80.340"

W- 1-1/4"

Thickness- 3/16"

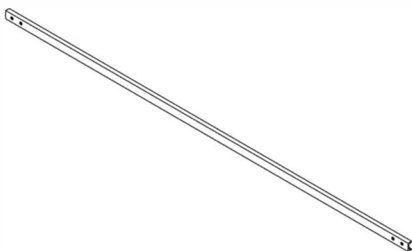

WSF-Sprinter

Spreader Bar

#180658

L- 56.375"

W- 1"

H-1/2"

Thickness- 1/8"

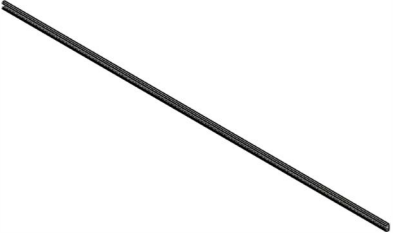
	<p>WSF-Sprinter-Transit</p> <p>Left Unistrut</p> <p>#180137</p> <p>L- 106"</p> <p>W- 1-5/8"</p> <p>H-13/16"</p>
---	---

	<p>WSM-Sprinter-Transit</p> <p>Left Wall Gear Rack</p> <p>#180175</p> <p>L- 80"</p> <p>W- 0.7874"</p>
---	---

	<p>WSF-Sprinter-Transit</p> <p>Lower Horizontal</p> <p>#180102</p> <p>L- 55.063"</p> <p>W- 1-1/4"</p> <p>H-1-1/4"</p>
---	---



WSF-Sprinter-Transit

Right Unistrut

#180138

L- 59"

W- 1-5/8"

H- 13/16"



WSM-Sprinter-Transit

Right Wall Gear Rack

#180174

L- 49"

W- 0.7874"

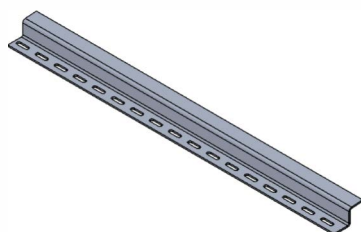

WSF-Sprinter-Transit

Snake Track Support

#180315

L- 30"

W- 3.113"

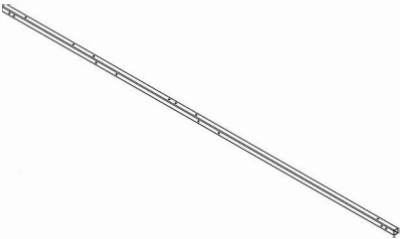
	<p>WSF-Sprinter-Transit</p> <p>Upper Horizontal</p> <p>#180100</p> <p>L- 108"</p> <p>W- 1-1/4"</p> <p>H- 1-1/4"</p>
---	---

	<p>WSF-Transit</p> <p>Cross Support</p> <p>#180104</p> <p>L- 57.125"</p> <p>W- 1-1/4"</p> <p>H- 1-1/4"</p>
--	--

	<p>WSF-Transit</p> <p>Front Stabilizer</p> <p>#180111</p> <p>L- 77.210"</p> <p>W- 1-1/4"</p> <p>Thickness- 3/16"</p>
---	--

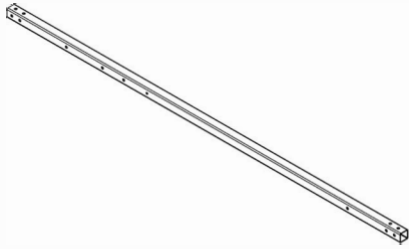

WSF-Transit

Main Upright

#180101

L- 61-1/4"

W- 1-1/4"

H- 1-1/4"

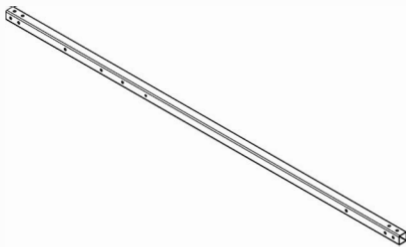

WSF-Transit

Mid Upright

#180103

L- 48-1/2"

W- 1-1/4"

H- 1-1/4"



WSF-Transit

Rear Stabilizer

#180110

L- 81.320"

W- 1-1/4"

Thickness- 3/16"

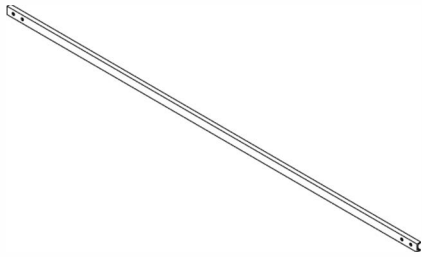

WSF-Transit
Spreader Bar

#180657

L- 57.125"

W- 1"

H- 1/2"



WSP-Sprinter-Transit
Handle Connecting Rod

#180321

L- 29.63"

D- 0.188"

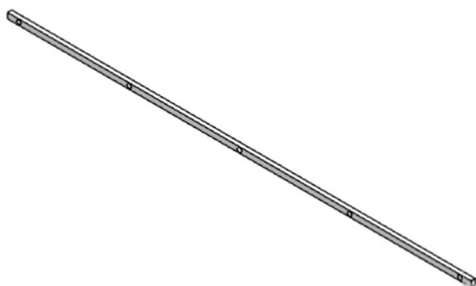

WSP-Sprinter-Transit
Left Wall Canopy Plastic Guide

#180198

L- 84"

W- 0.750"

H- 1"

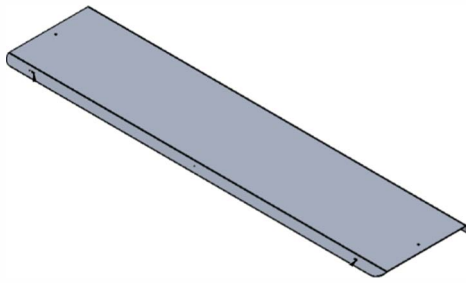

WSP-Sprinter-Transit

Left Wall Canopy

#180286

L- 84"

W- 19.561"

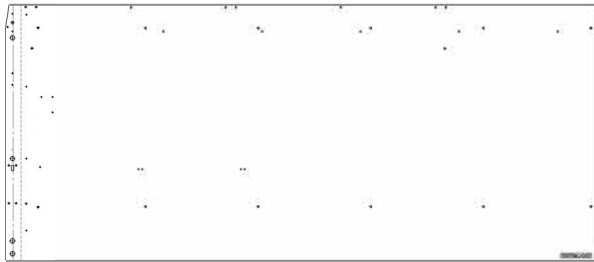

WSP-Sprinter-Transit

Left Wall Panel

#180177

L- 112.355"

W- 50"



WSP-Sprinter-Transit

Actuator Connecting Rod

#180316

L- 21"

D-0.188"

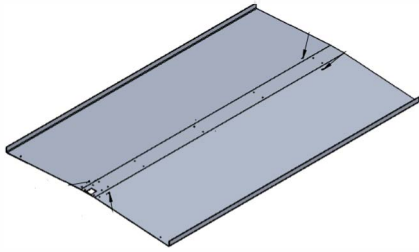

WSP-Sprinter-Transit

Canopy

#180187

L- 80.875"

W- 54.829"



WSR-Sprinter-Transit

Canopy Bearing Rail

#180180

L- 110"

W- 2.875"



WSP-Sprinter-Transit

Canopy Guide Bracket

#180519

L- 3.563"

W- 1"

H- 2.5"



WSP-Sprinter-Transit

Canopy Handle

#180142

L- 16-1/2"

W- 1"

H- 1"

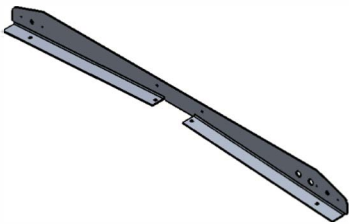

WSP-Sprinter-Transit

Ceiling Canopy Front End

#180186

L- 54.875"

W- 3.744"



WSP-Sprinter-Transit

Handle Connecting Rod

#180197

L- 29.75"

D- 0.250"

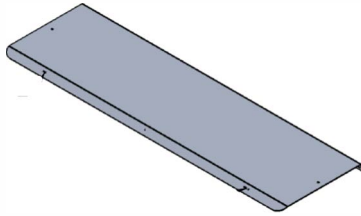

WSP-Sprinter-Transit

Right Wall Canopy

#180185

L- 66.980"

W- 19.561"

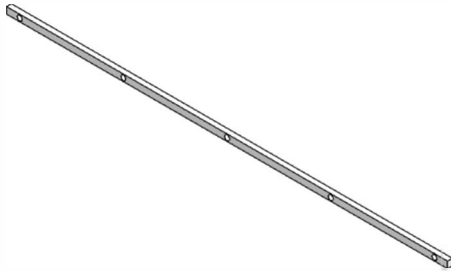

WSP-Sprinter-Transit

Right Wall Canopy Plastic Guide

#180199

L- 67.250"

W- 0.750"

H- 1"

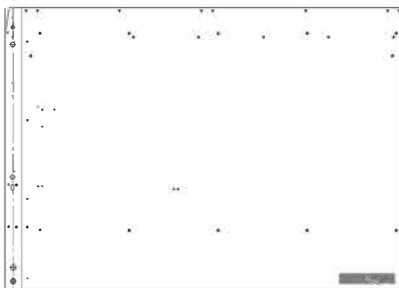

WSP-Sprinter-Transit

Right Wall Panel

#180178

L- 67.355"

W- 50"

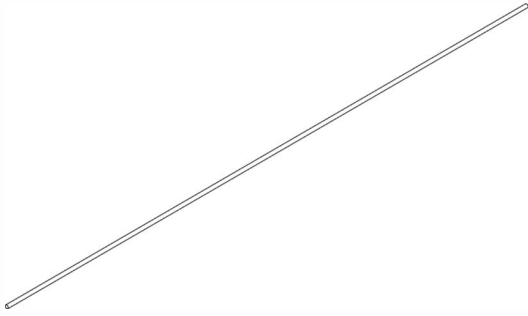

WSR-Sprinter-Transit

Canopy Latch Rod

#180520

L- 84"

D- 0.500"

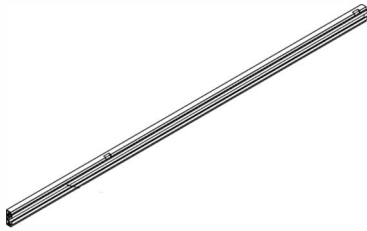

WSR-Sprinter-Transit

Canopy Sliding Rail

#180183

L- 110"

W- 3.875"



WSR-Sprinter-Transit

Left Lower Bearing Rail

#180181

L- 110"

W- 2.875"

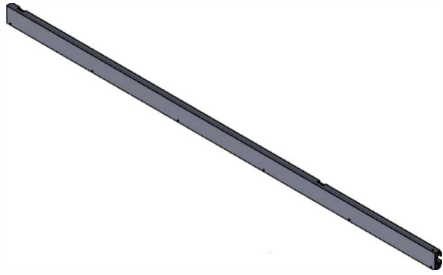

WSR-Sprinter-Transit

Left Sliding Rail

#180166

L- 110"

W- 3.875"



WSR-Sprinter-Transit

Left Upper Bearing Rail

#180165

L- 110"

W- 2.875"

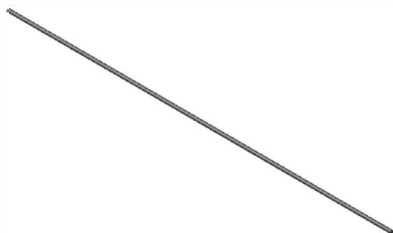

WSR-Sprinter-Transit

Left Wall Latch Rod

#180200

L- 83"

D- 1/2"



WSR-Sprinter-Transit
Right Lower Bearing Rail

#180182

L- 65"

W- 2.875"

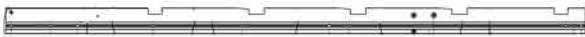

WSR-Sprinter-Transit
Right Upper Bearing Rail

#180167

L- 65"

W- 2.875"



WSR-Sprinter-Transit
Right Wall Latch Rod

#180312

L- 51-1/2"

D- 1/2"

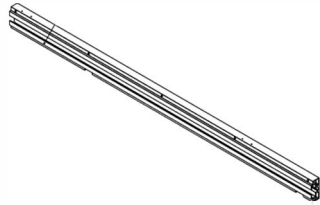

WSR-Sprinter-Transit

Right Sliding Rail

#180168

L- 65"

W- 3.875"

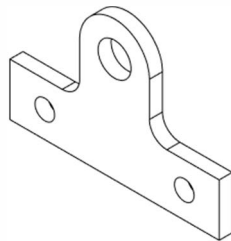

Canopy

Bearing Bracket

#180507

L- 3"

W- 2"

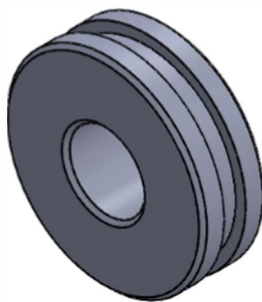

Canopy

Guide Bearing

#180508

H- 0.400"

D- 1.250"

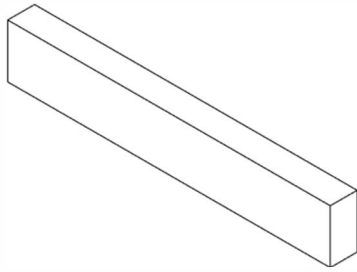

Canopy
Latch Handle Rod Tab

#180501

L- 2.250"

W- 0.375"

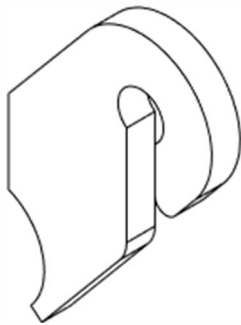

Canopy
Latch Spring Tab

#180500

L- 1.318"

W- 0.894"

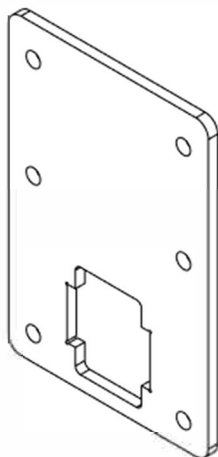

Canopy
Latch Base

#180483

L- 5.875"

W- 4"

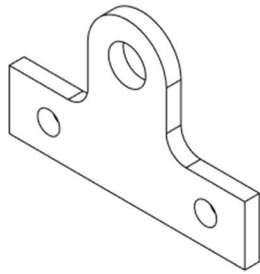

Canopy

Bearing Bracket

#180507

L- 3"

W- 2"

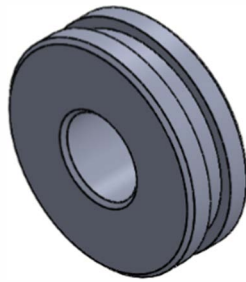

Canopy

Guide Bearing

#180508

H- 0.400"

D- 1.250"

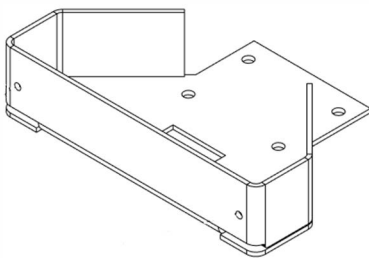

Canopy

Latch Pin Cover

#180541

L- 8.500"

W- 6.125"

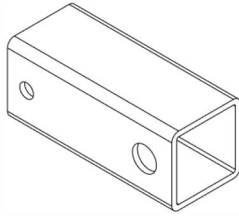

Canopy

Latch Handle Adapter Tube

#180485

L- 3"

W- 1-1/4"

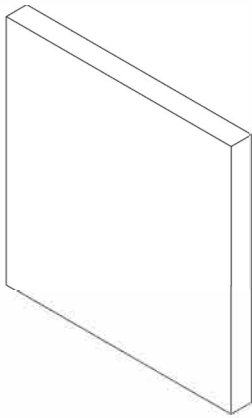

Canopy

Latch Lift Plate

#180486

L- 2.058"

W- 2.125"

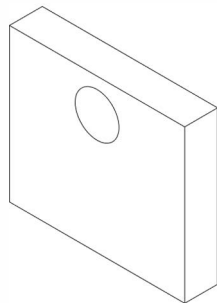

Canopy

Latch Pin Tab

#180484

L- 1"

W- 0.870"

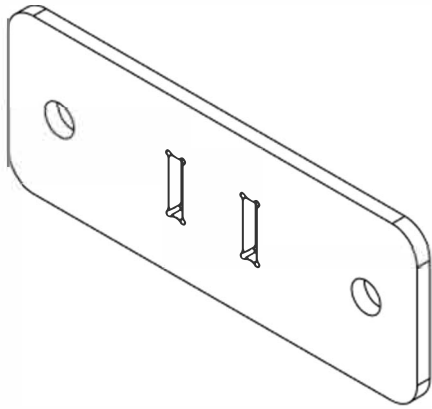

Folding Ladder Rack

Base

#180481

L- 4"

W- 1.500"

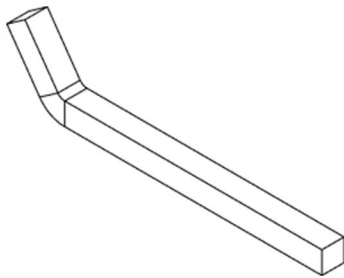

Folding Ladder Rack

Hook 2

#180488

L- 7.500"

W- 0.500"

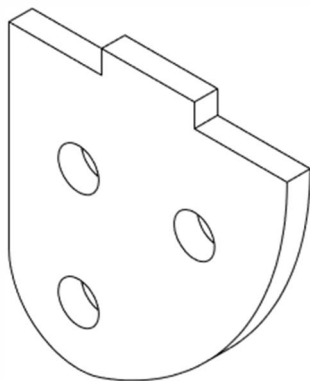

Folding Ladder Rack

Pivot Plate

#180482

L- 1.540"

W- 1.500"

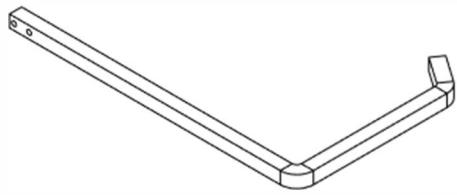

Folding Ladder Rack

Main Hook

#180487

L- 11.895"

W- 7.537"

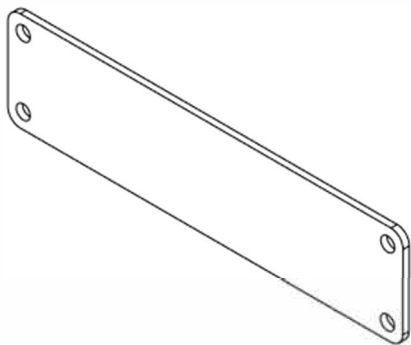

Logo Plate

Back Plate

#180504

L- 8"

W- 2"

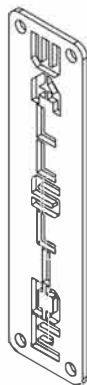

WallSlide Vertical

Logo Plate

#180532

L- 8"

W- 2"

